

CATALOGUE Général



www.sememdistributors.com



SEMEM DISTRIBUTORS SARL

Sommaire

**1. MATERIELS ET PRODUITS DE
SOUDAGE**

2. MATERIEL ELECTRIQUE

3. MATERIEL ELECTROPORTATIF

**4. EQUIPEMENT DE PROTECTION
INDIVIDUELLE**

**5. MATERIEL DE CONSTRUCTION
& QUINCAILLERIE**

**6. EQUIPEMENTS ET OUTILLAGES
INDUSTRIELS ET ARTISANAUX**

7. MATERIEL FORESTIER ET SCIERIE



PRESENTATION DE L'ENTREPRISE

SEMEM DISTRIBUTORS SARL

1. HISTORIQUE DE L'ENTREPRISE

L'entreprise SEMEM DISTRIBUTORS SARL a été créée en Juillet 1995 tel que indiqué sur les documents administratifs ; mais en réalité la structure a vu le jour en 1988 sous l'appellation SEMEM SARL (Société d'Entretien et de Maintenance des Appareils ElectroMécaniques). Elle n'était à ses débuts qu'une entreprise de maintenance en électromécanique, soudage, rebobinage, recharge de gaz industriel etc. et agissait comme prestataire ou sous-traitant auprès des entreprises industrielles qui sollicitaient son expertise technique.

SEMEM DISTRIBUTORS SARL est né d'un souci d'expansion dans le domaine de la distribution. L'entreprise a donc étendu son activité de distribution dans divers secteurs (forestier et scierie, transport, sécurité et protection, construction, artisanal, agricole et industrielle ...) et s'est dotée en 2005 d'une usine de production des tôles, pointes et fer à béton. SEMEM DISTRIBUTORS SARL est aujourd'hui comptée parmi les leaders camerounais de la distribution du matériel industriel et construction ; Elle continue à nourrir des grandes ambitions allant de l'expansion et diversification de son activité à l'internationalisation.

2. MISSION ET VISION DE L'ENTREPRISE

VISION SEMEM DISTRIBUTORS

« Etre le premier choix dans le secteur de distribution des matériaux industriels et de construction ; le premier choix, c'est le meilleur choix ; et être le meilleur constitue le leitmotiv de l'engagement de SEMEM DISTRIBUTORS »

MISSION SEMEM DISTRIBUTORS

«SEMEM DISTRIBUTORS fut créée dans l'optique d'importer et distribuer sur les marchés Camerounais, de la sous-région d'Afrique Centrale des matériaux industriels et de construction d'origine afin de s'assurer de son immersion jusqu'aux confins des consommateurs exigeants en terme de qualité et de durabilité pour une satisfaction inégalable. Pour y parvenir, nous nous donnons les ressources adéquates et efficaces permettant de fournir un produit et un service exceptionnel à notre clientèle et de satisfaire l'attente de nos partenaires. »

3. L'ACTIVITE DE L'ENTREPRISE

SEMEM DISTRIBUTORS a pour cœur de métier l'Importation et la Distribution des équipements, matériels, matériaux, outillages industriels d'origine tant pour le secteur industrielle que pour le secteur artisanale.

Notre gamme composée de plus de 3 000 produits répartis en famille : Matériel de soudure, matériel forestier et scierie, matériel de construction, le matériel électroportatif, les équipements de protection individuelle, l'outillage agricole et artisanale, la quincaillerie industrielle, le matériel électrique etc. Toute cette gamme nous permet de ravitailler des secteurs d'activité variés tels que : les BTP, la construction métallique et chaudronnerie, les garages automobiles, les entreprises de transport, le secteur agricole et artisanal, les exploitants forestiers, les exploitants miniers, la menuiserie bois et aluminium, les industries manufacturières etc.

A travers son Usine de Production située à la Zone Industrielle de Bassa Douala, le groupe SEMEM excelle dans la transformation des métaux, notamment la production des Pointes ordinaires et Fer à béton ; le façonnage des Tôles Aluminium simples, Tôles Aluminium laquées et Accessoires de toitures.

4. IMPLANTATION ET RESEAU DE DISTRIBUTION

L'entreprise SEMEM DISTRIBUTORS SARL a pour siège social DOUALA AKWA, quartier BONADIBONG, RUE GALLIENI ; lieu-dit CARREFOUR TIFF. Par ailleurs, elle dispose d'un important réseau de distribution, desservant non seulement l'ensemble du triangle national (avec les agences dans tous les grands pôles d'attraction à savoir : DOUALA, YAOUNDE, BAFOUSSAM, GAROUA) mais aussi la sous-région d'Afrique Centrale grâce à l'action de nos partenaires basés dans les pays voisins.

5. NOS MARQUES



Materiels & Produits
SOUDAGE



SEMEM DISTRIBUTORS SARL

Matériel de soudage

L'appellation de soudage s'applique dès lors que deux pièces sont réunies de façon à ce que la continuité de la matière entre les deux éléments soit telle qu'au niveau atomique ces deux pièces n'en forment qu'une seule.

Pour cela, le soudage requiert une dilution du métal d'apport dans les matériaux à souder.

Sommaire

ELECTRODES

POSTES A SOUDER

ACCESSOIRES DE SOUDAGE ELECTRIQUE

MATERIEL SOUDAGE FLAMME

MATERIEL AEROPRONE

PROTECTION DU SOUDEUR

ABRASIF



SEMEM DISTRIBUTORS SARL

ELECTRODES

1. ELECTRODES SAF

ELECTRODE RUTILE 6013



ELECTRODE SAFER G48N dia 2,5 x 350
ELECTRODE SAFER G48N dia 3,2 x 350
ELECTRODE SAFER G48N dia 4 x 350
ELECTRODE SAFER G48N dia 3,2 x 450
ELECTRODE SAFER G48N dia 4 x 450



ELECTRODE RAPIDARC dia 2,5 x 350
ELECTRODE RAPIDARC dia 3,2 x 350
ELECTRODE RAPIDARC dia 4 x 350

ELECTRODE BASIQUE 7018



ELECTRODE SAFER NF 510 dia 2,5 x 350
ELECTRODE SAFER NF 510 dia 3,2 x 350
ELECTRODE SAFER NF 510 dia 4 x 350
ELECTRODE SAFER NF 510 dia 3,2 x 450
ELECTRODE SAFER NF 510 dia 4 x 450



ELECTRODE RESISTARC dia 2,5 x 350
ELECTRODE RESISTARC dia 3,2 x 350
ELECTRODE RESISTARC dia 4 x 350
ELECTRODE RESISTARC dia 3,2 x 450
ELECTRODE RESISTARC dia 4 x 450

ELECTRODE SAFINOX



SAFINOX 316L dia 2,5 x 350
SAFINOX 316L dia 3,2 x 350
SAFINOX 316L dia 4 x 350
SAFINOX 312 dia 2,5 x 350
SAFINOX 312 dia 3,2 x 350
SAFINOX 312 dia 4 x 350

ELECTRODE FONTE



STARCAST dia 2,5 x 350
STARCAST dia 3,2 x 350
STARCAST dia 4 x 350

ELECTRODE ALUMINIUM

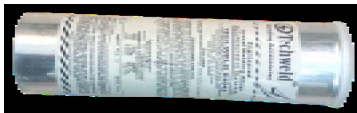

SAFALU SI dia 2,5 x 350
SAFALU SI dia 3,2 x 350

ELECTRODE DE RECHARGEMENT



SAFER R400 dia 3,2 x 450
SAFER R400 dia 4 x 450
SAFER R600 dia 3,2 x 450
SAFER R600 dia 4 x 450
SAFMANGA dia 3,2 x 450
SAFMANGA dia 4 x 450
SAFDUR 800 E dia 4 x 450



SAFER CARBONNE Dia 4 étuis de 100
SAFER CARBONNE Dia 5 étuis de 100
SAFER CARBONNE Dia 6 étuis de 50
SAFER CARBONNE Dia 8 étuis de 50

METAUX D'APPORT



ACIER DOUX CU40 dia 2
ACIER DOUX CU40 dia 3
ACIER DOUX CU40 dia 4



ACIER DOUX CU60 dia 2
ACIER DOUX CU60 dia 3
ACIER DOUX CU60 dia 4



NERTAL INOX 316 dia 1,6
NERTAL INOX 316 dia 2,4
NERTAL INOX 316 dia 3,2



BRASURE BROX AS dia 2
BRASURE BROX AS dia 3
BRASURE BROX AS dia 4



BRASURE ARGENT à 30% Etuis
BRASURE ARGENT à 40% Etuis



FIL POUR SOUDAGE ACIER MIG 70S dia 0,8
FIL POUR SOUDAGE ACIER MIG 70S dia 1,0
FIL POUR SOUDAGE ACIER MIG 70S dia 1,2



FIL POUR SOUDAGE ALU dia 1,2
FIL POUR SOUDAGE ALU dia 1,6

2. ELECTRODES ESAB

BASIQUE 7018



OK 48.00 dia 2,5 x 350
OK 48.00 dia 3,2 x 350
OK 48.00 dia 4 x 350
OK 48.00 dia 3,2 x 450
OK 48.00 dia 4 x 450

INOX



OK 63-30 dia 2,5 x 350
OK 63-30 dia 3,2 x 350
OK 63-30 dia 4 x 350
OK 68-82 dia 2,5 x 350
OK 68-82 dia 3,2 x 350
OK 68-82 dia 4 x 350

FONTE



OK 92-58 dia 2,5 x 350
OK 92-58 dia 3,2 x 350
OK 92-58 dia 4 x 350
OK 92-18 dia 2,5 x 350
OK 92-18 dia 3,2 x 350
OK 92-18 dia 4 x 350
OK 92-26 dia 2,5 x 350
OK 92-26 dia 3,2 x 350
OK 92-26 dia 4 x 350

ELECTRODE ALUMINIUM



OK 96.50 dia 2,5
OK 96.50 dia 3,2
OK 96.50 dia 4

ELECTRODE DE RECHARGEMENT



OK 74-78 dia 3,2
OK 84-73 dia 4
OK 83-28 dia 3,2
OK 83-28 dia 4
OK 83-50 dia 3,2
OK 83-50 dia 4

ELECTRODE DE GOUGEAGE



OK 21.03 dia 3,2 x 350
OK 21.03 dia 4 x 350

METAL D'APPORT ACIER



TIG ROD 12-60 dia 1,6
TIG ROD 12-60 dia 2
TIG ROD 12-60 dia 3,2

3. ELECTRODES GEKA

ETUVES



Etuves

ELECTRODE GEKA INTER



Electrode GEKA INTER (Rutile)

ELECTRODE GEKA LAZER



Electrode GEKA LAZER (Basique)

POSTE À SOUDER

1. MMA procédé (Poste électrode Enrobée)



POSTE SAFEX C2



POSTE RODARC 300
POSTE RODARC 400
POSTE RODARC 450



BUFFALO 400
BUFFALO 500
BUFFALO 650



SAXO 1600

2. MIG procédé Metal inerte (Gaz)



POSTE DE SOUDURE MIG



BLUMIG 353C



BLUMIG 503SH

3. TIG procédé Tungstène inerte (Gaz)



TIG AC DC 207



PRESTOTIG 175
PRESTOTIG 310 DC



TIG AC DC 200



TIG AC DC 220



TIG AC DC 250

4. PLASMA



GYS CUTTER 85A



POSTE DE DECOUPAGE ELECTRIQUE
PLASMAJET 2C
POSTE DE DECOUPAGE ELECTRIQUE
PLASMAJET 4C

5. Autres



FILCORD 353C



GRUPE AUTONOME DE SOUDURE :
France POWER FP220DC

ACCESSOIRES DE SOUDAGE ÉLECTRIQUE

PINCE PORTE ELECTRODE



PINCE PORTE ELECTRODE MASTER 500A



PINCE PORTE ELECTRODE GYS 500A

PRISE DE MASSE



PRISE DE MASSE A RESSORT 300A
PRISE DE MASSE A RESSORT 600A
PRISE DE MASSE SERREJOINT 500A

RACCORD UNIVERSEL



RACCORD UNIVERSEL MALE



RACCORD UNIVERSEL FEMELLE

CABLE DE SOUDURE



CABLE DE SOUDURE dia 50mm
CABLE DE SOUDURE dia 70mm
CABLE DE SOUDURE dia 95mm

MASQUE DE SOUDURE



MASQUE DE SOUDURE

CASQUE DE SOUDURE



CASQUE DE SOUDURE VERRE T11
CASQUE DE SOUDURE A CRISTAUX LIQUIDE

MATERIEL DE SOUDURE FLAMME

CHALUMEAU



CHALUMEAU VARIAL 400



CHALUMEAU VARIAL G2



CHALUMEAU FIXAL G2



CHALUMEAU DECOUPEUR PYROCOPT G1

DETENDEUR



DETENDEUR EUROSAF AD



DETENDEUR EUROSAF OX



DETENDEUR MANOBLOC 4 OX



DETENDEUR MANOBLOC 4 AD



DETENDEUR ARGON / CO2



DETENDEUR MINIBLOC ARGON



DETENDEUR ROTAMETRE ARGON / CO2



DETENDEUR GRAND DEBIT OX



DETENDEUR GRAND DEBIT AD

KIT LORMATIC OX / AD



KIT LORMATIC OX / AD

ANTIRETOUR OX / AD CHALUMEAU



ANTIRETOUR OX / AD CHALUMEAU

ANTIRETOUR OX / AD DETENDEUR



ANTIRETOUR OX / AD DETENDEUR

ALLUME GAZ



ALLUME GAZ

SILEX ALLUME GAZ



SILEX ALLUME GAZ

LUNETTE DE SOUDAGE



LUNETTE DE SOUDAGE

LUNETTE DE MEULAGE CLAIRE



LUNETTE DE MEULAGE CLAIRE

TUYAUX DE SOUDURE



TUYAU DE SOUDURE BLEU OX D10



TUYAU DE SOUDURE ROUGE AD D10



TUYAUX JUMEAUX BLEU / ROUGE D10



TUYAUX DE SOUDURE OX/AD D6

COLLIER SERFLEX



COLLIER SERFLEX

MATERIEL AEROPROPANE

CHALUMEAU TORNADO 2019



CHALUMEAU TORNADO 2019

CAMPING GAZ



CAMPING GAZ

CHALUMEAU + TUYAU + DETENDEUR



CHALUMEAU + TUYAU + DETENDEUR

CHALUMEAU A LEVIER ETANCHEITE LONG



CHALUMEAU A LEVIER ETANCHEITE LONG

CHALUMEAU A LEVIER ETANCHEITE MOYEN



CHALUMEAU A LEVIER ETANCHEITE MOYEN

PROTECTION DU SOUDEUR

PROTECTION DES MAINS



GANT SOUDEUR LONG
GANT SOUDEUR COURT
GANT ANTI CHALEUR

PROTECTION DES YEUX



LUNETTE UV 400 CLAIR
LUNETTE UV 400 TEINTE

PROTECTION DU CORPS ET PIEDS



TABLIER SOUDEUR CUIR



GENOUILLEUR SOUDEUR



VESTE SOUDEUR CUIR



BOLERO SOUDEUR CUIR



MANCHETTE



GUETRE SOUDEUR CUIR



CHAUSSURES DE SECURITE

TETE DE COUPE



TETE DE COUPE OX/AD 7/10
TETE DE COUPE OX/AD 10/10
TETE DE COUPE OX/AD 12/10
TETE DE COUPE OX/AD 16/10

TETE DE COUPE OX/AD 20/10
TETE DE COUPE OX/AD 25/10
TETE DE COUPE OX/AD 30/10



TETE DE COUPE OX-BUTANE 7/10
TETE DE COUPE OX-BUTANE 10/10
TETE DE COUPE OX-BUTANE 12/10
TETE DE COUPE OX-BUTANE 16/10

TETE DE COUPE OX-BUTANE 20/10
TETE DE COUPE OX-BUTANE 25/10
TETE DE COUPE OX-BUTANE 30/10

ABRASIF

DISQUE A MEULER



DISQUE A MEULER 230x6,5x22,2
DISQUE A MEULER 125x6,5x22,2
DISQUE A MEULER 115x6,5x22,2

DISQUE A TRONCONNER



DISQUE A TRONCONNER 230X3,2
DISQUE A TRONCONNER 230X2,5
DISQUE A TRONCONNER 125X3,2
DISQUE A TRONCONNER 125X2,5
DISQUE A TRONCONNER 115X3,2
DISQUE A TRONCONNER 115X2,5
DISQUE A TRONCONNER 125X1
DISQUE A TRONCONNER 115X1

DISQUE A LAMELLE



DISQUE A LAMELLE dia 115 OU 125
DISQUE A LAMELLE dia 180

DISQUE A PONCER dia 180



DISQUE A PONCER dia 180

PAPIER ABRASIF WATERPROOF 21-27



PAPIER ABRASIF WATERPROOF 21-27

Matériel

ELECTRIQUE

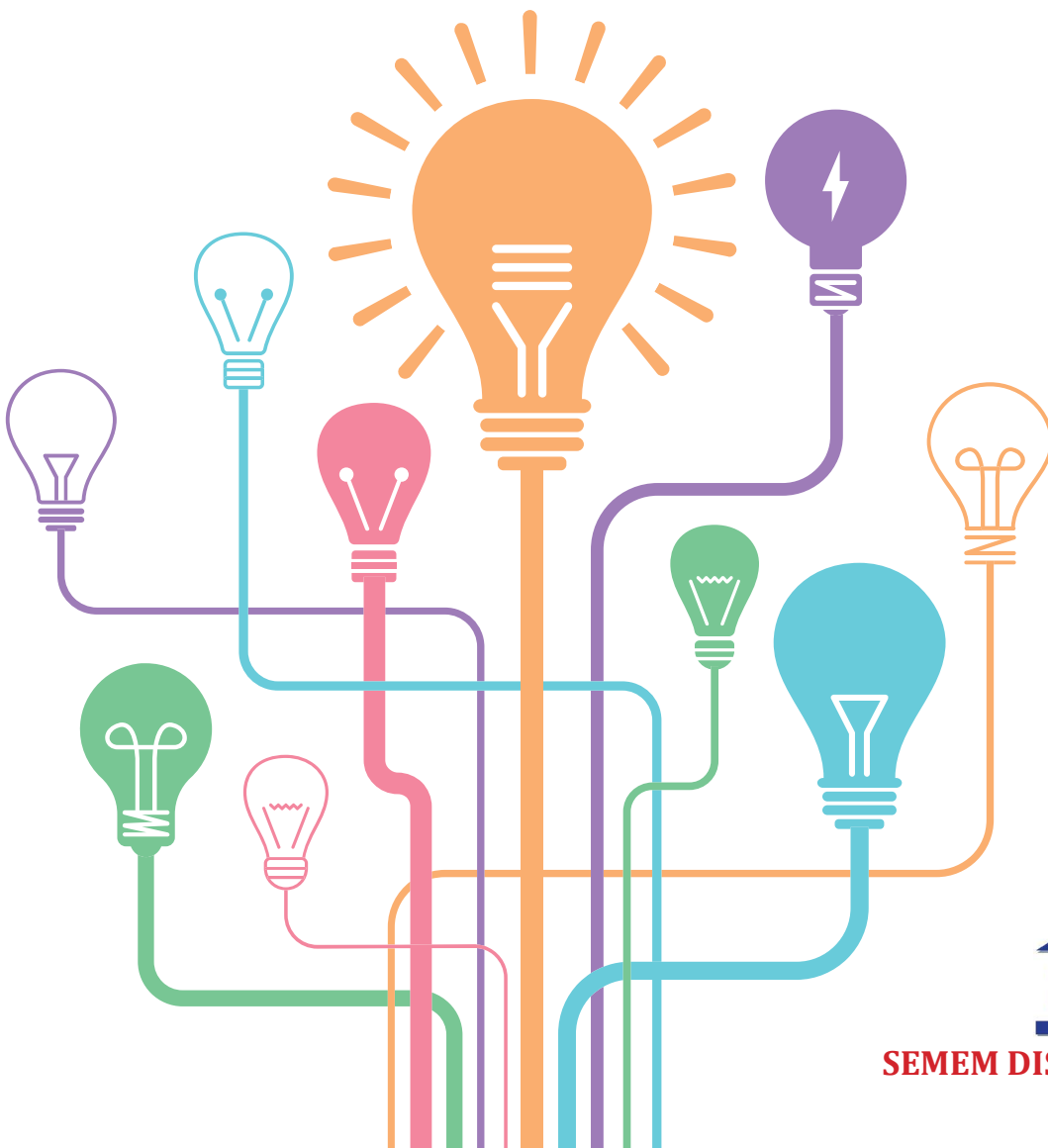

SEMEM DISTRIBUTORS SARL

Electrique

Se dit de dispositifs, de techniques, d'appareils qui produisent, transportent, stockent ou utilisent de l'énergie fournie par l'électricité.

Sommaire

- DIJONCTEUR RX3
- INTERRUPTEUR DIFFERENTIEL RX
- INTER HORAIRE
- DISMATIC
- BARRETTES DE CONNEXION
- COLLIERS COLSON
- FICHES
- BOITES D'ENCASTREMENT
- BOITES DE DERIVATION
- INTERRUPTEUR
- VA ET VIENT
- POUSSOIR LUMINEUX
- PRISE TELEPHONE
- PRISE TV SORTIE DE CABLE
- CARILLON
- KIT CARILLON RADIO
- ADAPTEUR
- PROGRAMMATEURS MENAGERS
- CHARGEURS USB
- RALLONGES MULTIPRISES
- COUTEAUX ET ACCESSOIRES ELECTRICIEN
- CABLE TH H07-VV
- CABLE R020V RIGIDE
- CABLE RV-K SOUPLE
- CABLE VGV
- GAINÉ ANNELE
- MULTIMETRE
- GROUPE ELECTROGENE



Réf.	Désignation	Conditionnement
------	-------------	-----------------

DIJONCTEUR RX3



419946	Disjoncteurs RX ³ 4500 - 1P+N - 230V \sim - 6 A - courbe C - Neutre à gauche	Boîte
419947	Disjoncteurs RX ³ 4500 - 1P+N - 230V \sim - 10 A - courbe C - Neutre à gauche	Boîte
419949	Disjoncteurs RX ³ 4500 - 1P+N - 230V \sim - 16 A - courbe C - Neutre à gauche	Boîte
419950	Disjoncteurs RX ³ 4500 - 1P+N - 230V \sim - 20 A - courbe C - Neutre à gauche	Boîte
419951	Disjoncteurs RX ³ 4500 - 1P+N - 230V \sim - 25 A - courbe C - Neutre à gauche	Boîte
419952	Disjoncteurs RX ³ 4500 - 1P+N - 230V \sim - 32 A - courbe C - Neutre à gauche	Boîte



419705	Disjoncteurs RX ³ 4500 - 3P - 400V \sim - 6 A - courbe C	Boîte
419706	Disjoncteurs RX ³ 4500 - 3P - 400V \sim - 10 A - courbe C	Boîte
419708	Disjoncteurs RX ³ 4500 - 3P - 400V \sim - 16 A - courbe C	Boîte
419709	Disjoncteurs RX ³ 4500 - 3P - 400V \sim - 20 A - courbe C	Boîte
419710	Disjoncteurs RX ³ 4500 - 3P - 400V \sim - 25 A - courbe C	Boîte
419711	Disjoncteurs RX ³ 4500 - 3P - 400V \sim - 32 A - courbe C	Boîte
419712	Disjoncteurs RX ³ 4500 - 3P - 400V \sim - 40 A - courbe C	Boîte
419713	Disjoncteurs RX ³ 4500 - 3P - 400V \sim - 50 A - courbe C	Boîte
419714	Disjoncteurs RX ³ 4500 - 3P - 400V \sim - 63 A - courbe C	Boîte



419738	Disjoncteurs RX ³ 4500 - 4P - 400V \sim - 6 A - courbe C	Boîte
419739	Disjoncteurs RX ³ 4500 - 4P - 400V \sim - 10 A - courbe C	Boîte
419741	Disjoncteurs RX ³ 4500 - 4P - 400V \sim - 16 A - courbe C	Boîte
419742	Disjoncteurs RX ³ 4500 - 4P - 400V \sim - 20 A - courbe C	Boîte
419743	Disjoncteurs RX ³ 4500 - 4P - 400V \sim - 25 A - courbe C	Boîte
419744	Disjoncteurs RX ³ 4500 - 4P - 400V \sim - 32 A - courbe C	Boîte
419745	Disjoncteurs RX ³ 4500 - 4P - 400V \sim - 40 A - courbe C	Boîte
419746	Disjoncteurs RX ³ 4500 - 4P - 400V \sim - 50 A - courbe C	Boîte
419747	Disjoncteurs RX ³ 4500 - 4P - 400V \sim - 63 A - courbe C	Boîte

INTERRUPTEUR DIFFERENTIEL



402024	ID RX ³ - 2P - 230 V \sim - 25 A - 30 mA - AC type	Boîte
402025	ID RX ³ - 2P - 230 V \sim - 40 A - 30 mA - AC type	Boîte
402026	ID RX ³ - 2P - 230 V \sim - 63 A - 30 mA - AC type	Boîte



402062	ID RX ³ - 4P - 400 V \sim - 25 A - 30 mA - AC type	Boîte
402063	ID RX ³ - 4P - 400 V \sim - 40 A - 30 mA - AC type	Boîte
402064	ID RX ³ - 4P - 400 V \sim - 63 A - 30 mA - AC type	Boîte

INTER HORAIRE



003705	INT.HOR.DIG.16A 120/230V 1MOD	Boîte
412790	IH ANALOGIQUE J 1M RDM	Boîte
412795	IH ANALOGIQUE J 3M RDM	Boîte

DISMATIC



782429	Disjoncteur DISMATIC 20A BLANC FORIX	Boîte
764618	DISMATIC 15A IVOIRE	Boîte
764619	DISMATIC 20A IVOIRE	Boîte
764518	DISMATIC 15A BLANC	Boîte
764519	DISMATIC 20A BLANC	Boîte

Réf.	Désignation	Conditionnement
------	-------------	-----------------

BARRETTES DE CONNEXION



34211	Barrette de connexion Nylbloc - cap 2,5 mm ² - noir	Boîte
34213	Barrette de connexion Nylbloc - cap 6 mm ² - noir	Boîte
34215	Barrette de connexion Nylbloc - cap 10 mm ² - noir	Boîte
34217	Barrette de connexion Nylbloc - cap 16 mm ² - noir	Boîte
34219	Barrette de connexion Nylbloc - cap 25 mm ² - noir	Boîte

COLLIERS COLSON



31913	Colliers Colson 9x185	Carton
31916	Colliers Colson 9x262	Carton
31919	Colliers Colson 9x357	Carton

FICHES



50415	Fiche 2P+T - 16 A - plastique - sortie droite - blanc	Boîte
-------	---	-------



50416	Fiche 2P+T - 16 A - plastique - sortie latérale - blanc	Boîte
-------	---	-------



50420	Fiche 2P+T - 16 A - plastique - anneaux - blanc	Boîte
-------	---	-------



50424	Fiche 2P+T - 16 A - plastique - anneaux - gris	Boîte
-------	--	-------



50421	Prolongateur 2P+T - 16 A - plastique - anneaux - blanc	Boîte
-------	--	-------



50425	Prolongateur 2P+T - 16 A - plastique - anneaux - gris	Boîte
-------	---	-------



50445	Fiche 2P+T - 16 A - caout - sortie droite - IP 44 - IK 08 - câble Ø2,5 mm ²	Boîte
-------	--	-------



50446	Prolongateur - 16 A - caout - sortie droite - IP 44 - IK 08 - câble Ø2,5 mm ²	Boîte
-------	--	-------

BOITES D'ENCASTREMENT



80141	Boîte monoposte Batibox - maçonnerie - carrée associable - prof. 40	Boîte
-------	---	-------



31301	Boîte d'encastrement Diamètre 65	Boîte
-------	----------------------------------	-------

BOITES DE DERIVATION



92001	Bte ronde - Ø 60/h 40 étanche Plexo gris - embout (4) -IP55/IK07- 650°C	Boîte
-------	---	-------













92032	Bte carrée 130x130x74 étanche Plexo gris - embout (10) - IP55/IK07 - 650°C	Boîte
-------	--	-------



92042	Bte rect 155x110x74 étanche Plexo gris - embout (10) -IP55/IK07- 750°C	Boîte
-------	--	-------

	Réf.	Désignation	Conditionnement
INTERRUPTEUR			
	782100	Interrupteur - 10 AX - 250 V~	Boîte
	782104	Va-et-Vient - 10 AX - 250 V~	Boîte
	782101	Interrupteur à voyant - 10 AX - 250 V~	Boîte
	782102	Double Interrupteur - 10 AX - 250 V~	Boîte
	782129	Double va-et-vient - 10 AX - 250 V~	Boîte
	782103	Double interrupteur à voyant - 10 AX - 250 V~	Boîte
POUSSOIR LUMINEUX			
	782106	Poussoir lumineux 6 A - 250 V~	Boîte
PRISE TELEPHONE			
	782114	Prise téléphone RJ 11	Boîte
PRISE TV			
	782115	Prise Télévision	Boîte
SORTIE DE CABLE			
	782116	Sortie de câble	Boîte
CARILLON			
	41 651	Carillon 110-230 V~ - 50/60 Hz - 2 tons	Boîte
KIT CARILLON RADIO			
	94250	KIT ECO CARILLON RADIO BLISTER	Blister
ADAPTEUR			
	50383	Adaptateurs standard Britanique	
PROGRAMMATEURS MENAGERS			
	95860	Programmateur journalier - 230V -16 A - éq 1 fiche 2P+T / 1 socle 2P+T	Boîte
CHARGEUR USB			
	50680	Adaptateur USB blanc	Linéaire avancé
	50681	Adaptateur USB noir	Linéaire avancé

	Réf.	Désignation	Conditionnement
RALLONGES MULTIPRISES			
	050204	Rallonge 4 prises de courant - cordon 1,5 m - Bleu	Linéaire avancé
	050207	Rallonge 4 prises de courant - cordon 1,5 m - Noir	Linéaire avancé
	050205	Rallonge 4 prises de courant - cordon 1,5 m - Orange	Carton
	050055	Rallonge multiprise standard - 4x2P+T - cord 1,5 m	Carton
	050058	Rallonge multiprise standard - 5x2P+T - cord 1,5 m	Carton
	050052	Rallonge multiprise standard - 3x2P+T - cord 3 m	Carton
	050056	Rallonge multiprise standard - 4x2P+T - cord 3 m	Carton
	050059	Rallonge multiprise standard - 5x2P+T - cord 3 m	Carton
	050071	Rallonge multiprise confort - bloc de prises rotatif - 3x2P+T - cord 1,5 m	Carton
	050076	Rallonge multiprise confort - bloc de prises rotatif - 4x2P+T - cord 3 m	Carton
	050084	Rallonge multiprise confort - bloc de prises rotatif - 6x2P+T - cord 3 m	Carton
RALLONGES MULTIPRISES MULTIMEDIA			
	050097	Rallonge multiprise confort et sécurité - parafoudre - 6x2P+T	Carton
	050014	Rallonge verticale - 4x 2P+T avec inter + 2 USB + 1 micro USB - Blanc/gris	Linéaire avancé
	050394	Rallonge verticale - 4x 2P+T avec inter + 2 USB + 1 micro USB - Noir	
COUTEAUX ET ACCESSOIRES ELECTRICIEN			
	093081	TOURNEVIS TESTEUR DE COURANT	Boîte
	093080	COUTEAU D'ELECTRICIEN	Boîte
	032760	Pincés coupantes	Boîte

	Réf.	Désignation	Conditionnement
CABLE TH HO7-VU			
		CABLE TH 1,5mm	
		CABLE TH 2,5mm	
		CABLE TH 4mm	
		CABLE TH 6mm	
CABLE R02V RIGIDE			
		CABLE 2x1,5mm	
		CABLE 3x1,5mm	
		CABLE 3x2,5mm	
		CABLE 4x1,5mm	
		CABLE 4x2,5mm	
		CABLE 4x4mm	
		CABLE 4x6mm	
CABLE RV-K SOUPLE			
		CABLE 2x1,5mm	
		CABLE 3x1,5mm	
		CABLE 3x2,5mm	
		CABLE 4x1,5mm	
		CABLE 4x2,5mm	
		CABLE 4x4mm	
		CABLE 4x6mm	
CABLE VGV			
		CABLE 2x1,5mm	
		CABLE 3x1,5mm	
		CABLE 3x2,5mm	
GAINE ANNEE			
		GAINE ANNELEE DIA 16	
		GAINE ANNELEE DIA 20	
		GAINE ANNELEE DIA 25	
		GAINE ANNELEE DIA 32	
MULTIMETRE			
		MULTIMETRE 1000A AC	
GROUPE ELECTROGENE			
		2KVA, 3KVA, 4KVA, 5KVA, 6KVA, 8KVA, 10KVA	

Electropportatif



BOSCH

Makita



PEUGEOT



SEMEM DISTRIBUTORS SARL

Electroportatif

Relatif à un outil électrique qui se transporte, se porte, peut être bougé de façon aisée et simple.
En d'autres termes, un outillage électrique qui est portable.

Sommaire

MATERIEL BOSCH

MATERIEL MAKITA

MATERIEL FARTOOLS

MATERIEL PEUGEOT



SEMEM DISTRIBUTORS SARL

Matériel Bosch



SEMEM DISTRIBUTORS SARL

Meuleuses Bosch

	<p>MEULEUSE BOSCH GWS 8-115</p> <p>Puissance de prise de courant nominale: 800 W Régime à vide: 11.000 tr/min Puissance restituée: 500 W Filetage de la broche: M 14 Ø meule: 115 mm</p>
	<p>MEULEUSE BOSCH GWS 10-125</p> <p>Puissance de prise de courant nominale: 1.000 W Régime à vide: 11.000 tr/min Puissance restituée: 630 W Filetage de la broche: M 14 Ø meule: 125 mm</p>
	<p>MEULEUSE BOSCH GWS 17-125</p> <p>Puissance de prise de courant nominale: 1 500 W Régime à vide: 2.800 – 11.500 tr/min Filetage de la broche: M 14 x 1,5 Ø meule: 125 mm</p>
	<p>MEULEUSE BOSCH GWS 22-230</p> <p>Puissance de prise de courant nominale : 2200 W Régime à vide : 6500 tr/min Filetage de la broche : M 14 Ø meule : 230 mm Poids : 5,2 kg</p>
	<p>MEULEUSE BOSCH GWS 24-230</p> <p>Puissance de prise de courant nominale : 2400 W Régime à vide : 6600 tr/min Filetage de la broche : M 14 Poignée principale : Etrier orientable Ø meule : 230 mm</p>
	<p>MEULEUSE BOSCH GWS 26-230</p> <p>Puissance de prise de courant nominale: 2.600 W Régime à vide: 6.500 tr/min Filetage de la broche: M 14 Poignée principale: Moyeu plat Ø meule: 230 mm</p>
	<p>MEULEUSE D'ANGLE GGS 28</p> <p>Puissance: 650 W Vitesse de rotation: 10000 / 28000 rpm Réglage de rotation: oui Pince: 6 / 8 mm Poids: 1,4 kg</p>

Perceuses / Chignoles Bosch



PERCEUSE GSB 13 RE

Puissance absorbée nominale : 600 W
 Ø de perçage dans la maçonnerie : 15 mm
 Ø perçage bois : 25 mm
 Couple (vissage tendre) : 10,8 Nm
 Couple nominal : 1,8 Nm
 Filetage de la broche de perçage : 1/2» – 20 UNF
 Zone de serrage : 1,5 – 13 mm



PERCEUSE A PERCUSSION GSB 16 RE

Puissance absorbée nominale : 750 W
 Ø de perçage dans la maçonnerie : 18 mm
 Ø perçage bois : 30 mm
 Couple (vissage tendre) : 18,0 Nm
 Couple nominal : 2,3 Nm
 Filetage de la broche de perçage : 1/2» – 20 UNF
 Zone de serrage : 1,5 – 13 mm



PERCEUSE A PERCUSSION GBS 21-2RE

Puissance absorbée nominale : 1.100 w
 Régime à vide : 0 – 900 / 3.000 tr/min
 Puissance débitée : 630 w
 Poids : 2,9 kg
 Vitesse de rotation nominale : 0 – 580 / 1.900 tr/min
 Couple (vissage tendre) : 40,0 / 14,5 Nm



PERCEUSE MAGNETIQUE GBM 32

Puissance absorbée nominale : 1 500 W
 Régime à vide : 210 / 330 / 470 / 740 t/min
 Puissance restituée : 1 000 W
 Poids : 7,3 kg
 Vitesse de rotation nominale : 120 / 185 / 265 / 420 t/min
 Couple nominal : 80.0 / 52.0 / 36.0 / 32.0 Nm



PERCEUSE VISSEUSE GSR 18,8 - 2LI

Puissance : 18,8 V
 Capacité : 1.5 Ah
 Régime à vide : (vitesse 1/2) 0 - 400/0 - 1300 tr/min
 Batterie Lithium-ion 2Ah
 Couple maxi 59 Nm
 Variateur de vitesse



MARTEAU PERFORATEUR GBH 2-28 DFB

Puissance de prise de courant nominale : 850 W
 Force de frappe, max : 3,2 J
 Fréquence de frappe à vitesse de rotation nominale : 0 – 4,000 cps/min
 Vitesse de rotation nominale : 0 – 900 tr/min
 Poids : 3,1 kg

	MARTEAU PIQUEUR SDS MAX GSH 27BC
	Puissance absorbée nominale : 1 700 W Force de frappe : 23 J Fréquence de frappe à vitesse de rot. nom. : 900 – 1.700 cps/min Poids : 11,4 kg Tension, électrique : 230 V

	BRISE BETON GSH 16-28
	Puissance de prise de courant nominale : 1750 W Force de frappe, max : 41 J Fréquence de frappe à vitesse de rotation nominale : 2720 cps/min Poids : 17,9 kg Porte-outils : six pans femelle 28 mm

Ponceuses et Raboteuse Bosch

	PONCEUSE VIBRANTE GSS 280 AE
	Type d'alimentation : Filaire électrique Tension : 230 Volts Watt : 18 Watts Poids : 3.44 kilogrammes

	PONCEUSE A BANDE GBS 75 AE
	Vitesse de la bande : 200 – 330 m/min Surface abrasive, largeur : 75 mm Bande abrasive, longueur : 533 mm Bande abrasive, largeur : 75 mm Puissance absorbée nominale : 750 w

	PONCEUSE ELECTRIQUE GEX 125-AC
	Tension : 230 Volts Watt : 340 Watts Poids : 2.80 kilogrammes

	RABOTEUSE GH0 40-82C
	Puissance de prise de courant nominale: 850 W Epaisseur du copeau réglable: 0 - 4,0 mm Poids: 3,2 kg. Incertitude K: 1,5 m/s ² Epaisseur de feuillure réglable: 0 - 24 mm Régime à vide: 14.000 tr/min

	POLISSEUSE GPO 14 CE
	Puissance nominale : 1400 W Puissance utile : 800 W Vitesse de rotation à vide : 750-3000 tr/min Diamètre de la meule : 180 mm Poids : 2,5 kg

Scies Electriques Bosch





	SCIE SAUTEUSE GST 150 BCE
	Puissance nominale : 780 W Poids : 2,7 kg Longueur du câble : 4 m Hauteur de course : 26 mm Aspiration de la poussière

	<p>SCIE SAUTEUSE GST 90 BE</p> <p>Puissance absorbée : 650 W Vitesse à vide : 500-3,100 min-1 Poids : 2 à 6 kg Longueur de câble : 2 x 5 m</p>
	<p>SCIE CIRCULAIRE GKS 235</p> <p>Puissance absorbée nominale : 2 100 W Diamètre de la lame de scie : 235 mm Régime à vide : 5,000 t/min Poids : 7,6 kg Ø alésage : 25 mm</p>
	<p>SCIE A ONGLET BOSCH PROFESSIONAL SCIE A ONGLET RADIALE FILAIRE GCM 8 SJL</p> <p>Puissance absorbée nominale : 1600 W. Incertitude: 1.5 m/s² Coupe d'onglet : 52 ° G / 60 ° D Réglage d'inclinaison : 47 ° G / 2 ° D Diamètre de la lame : 216 mm Régime à vide : 5,500 tr/min</p>
	<p>DÉFONCEUSE BOSCH PRO GOF 900</p> <p>Puissance absorbée nominale: 900 W Porte-outils: 6 – 8,0 mm Régime à vide: 12.000 – 24.000 tr/min Course du berceau: 50 mm Poids: 3,5 kg</p>

Appareil Bosch Multifonction

	<p>OUTIL MULTIFONCTIONS BOSCH - PMF 350 CES</p> <p>Puissance débitée : 185 W Régime à vide : 15.000 – 20.000 tr/min Angle d'oscillation gauche/droit : 2,8 ° Poids du produit : 1,6 Kg</p>
---	--

Autres matériels Bosch

	<p>TELEMETRE BOSCH 120</p> <p>Portée du télémètre 120 m Mesure minimale 5 cm Unités de mesure m/cm/mm/ft/inch/ft-inch Écran Rétroéclairé automatique - Rotatif automatique</p>
	<p>MIRE</p> <p>Longueur 2,4 mètres Sections 2 Unités de mesure m/cm Matériau Aluminium</p>
	<p>TREPIED BOSCH</p> <p>Poids 1,3 kg Filetage 1/4" Hauteur maximale 1,57 m Hauteur minimale 0,55 m</p>
	<p>NIVEAU OPTIQUE 32G</p> <p>Unité de mesure 400 gon Grossissement 32 x Portée 120 M Poids approx. 1,7 kg</p>

Matériel Makita





SEMEM DISTRIBUTORS SARL

Meuleuses Makita

	<p>MEULEUSES MAKITA 840 - 115</p> <p>Puissance absorbée 840 Watt Diamètre du disque 115 mm - Type de raccord M14 Dimensions LxWxH 271 x 129 x 106 mm Poids 2,0 kg</p>
	<p>MEULEUSES MAKITA 1400 - 125</p> <p>Watt 1100 Watts Meuleuse ø 125 mm 1400 W Poids 2.50 kilogrammes</p>
	<p>MEULEUSES MAKITA 2200 – 230</p> <p>Puissance nominale 2200 W Vitesse à vide max. 6600 tr/min Diamètre du disque 230 mm Diamètre de l'alésage 22,23 mm Poids net 5,8 kg</p>
	<p>MEULEUSES MAKITA 2400 – 230</p> <p>Puissance nominale 2400 W Vitesse à vide max. 6600 tr/min Diamètre du disque 230 mm Diamètre de l'alésage 22,23 mm Poids net 6,3 kg</p>
	<p>MEULEUSES MAKITA 2600 – 230</p> <p>Puissance : 2 600 W Vitesse à vide 6 600 tours/min Diamètre du disque : 230 mm Poids 7 kg</p>

Perceuses / Chignoles Makita

	<p>PERCEUSE 450W 1-10mm</p> <p>Puissance nominale 450 W Vitesse à vide max. 0 à 3400 tr/min Poids net 1,6 kg</p>
	<p>PERCEUSE A PERCUSSION 710W 1-13mm</p> <p>Puissance nominale 710 W Poids net 1,9 kg</p>

	PERCEUSE A PERCUSSION 1010W 1-13mm
	Puissance nominale 1010 W Poids net 2,5 kg

	PERCEUSE VISSEUSE SANS FIL 14V
	Perceuse visseuse sans fil 14,4 V Type d'alimentation : Batterie Batterie : 2 batteries Li-Ion 1,3 Ah fournies Type de mandrin : Mandrin auto-serrant 10 mm mono bague

	PERCEUSE DEVISSEUSE HP343 DWE
	Fonction Percussion, perçage et vissage Tension 18 V Capacité de la batterie 3 Ah Poids net 1.7 kg

	MARTEAU PERFORATEUR 780W SDS + MANDRIN
	Puissance 780 W Couple 2.4 N•m Longueur du cordon 4 mètres Poids 2.90 kg

	MARTEAU DE FORAGE DEMALITION SDS 1350W
	Puissance 1350w Tension 230 v/50 Hz Nombre de percussion de 1 250/2 750 / min Poids 8,2 Kg

	MARTEAU PIQUEUR HM 1317C
	Puissance nominale 1510 W Puissance débitée maximale 1800 W Puissance maximale restituée 800 W Poids net 17 kg

	BRISE BETON HM 1304
	Puissance nominale (P1) 2000 W Cadence Cadence de frappe max. 1100 cps/min Taux de vibration triaxial (a h) 01/08/00 m/s ² Poids net 32,3 kg

Ponceuses et Raboteuses Makita

	PONCEUSE RECTANGULAIRE B03711
	Puissance nominale 190 W Puissance nominale débitée (P2) 70 W Nombre d'oscillations max. 4000 à 11000 orb/min Poids net EPTA 1,6 kg Longueur cordon d'alimentation 2 m

	PONCEUSE A BANDE 9401
	Puissance nominale 1040 W Vitesse de la bande maximale 350 m/min Poids net EPTA 7,4 kg Longueur cordon d'alimentation 5 m

	PONCEUSE EXCENTRIQUE 205041
	Puissance nominale 300 W Nombre d'oscillations max. 4000 à 12000 orb/min Amplitude d'oscillation 2,8 mm Poids net 1,4 kg Longueur cordon d'alimentation 2 m

	POLISSEUSE 927C
	Tension 230 Volts Watt 300 Watts Poids 3.40 kg

Scies Electrique Makita

	SCIE SAUTEUSE 26mm 4350CT
	Puissance nominale 720 W Puissance nominale débitée (P2) 320 W Puissance débitée maximale 700 W Cadence de coupe maximale 800 à 2800 cps/min Poids net EPTA 2,6 kg

	SCIE CIRCULAIRE 185mm
	Puissance nominale: 1100 W Vitesse à vide max.: 3500 tr/min Hauteur de coupe max. à 90°: 63 mm Capacité de coupe (acier): 6 mm

	SCIE CIRCULAIRE 285mm
	Puissance nominale (P1):2000 W Vitesse à vide max.: 4500 tr/min Dimensions (L x l x h): 400 x 185 x 286 mm Longueur cordon d'alimentation: 2,5 m Poids : 7,2 kg

	SCIE A ONGLET 255mm
	Puissance nominale 1500 W Vitesse à vide max. 4200 tr/min Dimensions (L x l x h) 610 x 485 x 515 mm Poids net EPTA 14,7 kg Longueur cordon d'alimentation 2,5 m



	SCIE A TABLE ET A ONGLET
	Puissance nominale 1650 W Vitesse à vide max. 2700 tr/min Dimensions (L x l x h) 660 x 650 x 1060 mm Poids net EPTA 36 kg Longueur cordon d'alimentation 2,5 m

Matériel Peugeot



SEMEM DISTRIBUTORS SARL



Meuleuses

	MEULEUSE ENERGYGrind 125
	Puissance 1 200 Watts Longueur du cordon 2 mètres Poids 2.75 kg
	MEULEUSE ENERGYGrind 230
	Puissance 1 200 Watts Longueur du cordon 2 mètres Poids 2.75 kg



Perceuses / Chignoles

	PERCEUSE A PERCUSSION 131VP
	Puissance 1 200 Watts Longueur du cordon 2 mètres Poids 2.75 kg
	PERCEUSE A PERCUSSION 132VP
	Puissance 1 100 Watts Longueur du cordon 2 mètres Poids 3.2 kg
	PERFORATEUR 4 FONCTIONS 324F
	Puissance 1 250 W 4,2 joules Mandrin SDS 2600 c/min
	PERCEUSE SANS FIL 14,4V 1014L
	Poids (Kg) 2,37 Tension (V) 14,4V Capacité de batterie (Ah) 1,3 Capacité du mandrin 10 mm



Ponceuses et Raboteuses

	PONCEUSE ORBITAL 1250R
	Puissance : 450 W Diamètre disque : 125 mm Vitesse à vide (orb/min) : de 7000 à 14000
	PONCEUSE VIBRANTE RECTANGULAIRE 187V
	Puissance 220 Watts Longueur du cordon 2 mètres Poids 1.75 kg

Scies Electrique

	<p>SCIE SAUTEUSE 800 JSV</p> <p>Puissance : 800 W Base inclinable : 0 à 45° Hauteur de coupe : 100 mm Cadence de coupe : 0 à 3000 cps/min</p>
	<p>SCIE CIRCULAIRE 185 LCS</p> <p>Puissance : 1 450 Watts Profondeur de coupe 185 mm Longueur du cordon 2 mètres Poids 4.85 kg</p>
	<p>RABOT ELECTRIQUE 910</p> <p>Puissance : 910 Watts Longueur du cordon 2 mètres Poids 3.60 kg</p>
	<p>SCIE A ONGLET RADIALE 2545L</p> <p>Puissance 1 600 W Diamètre 254 MM Capacité de coupe maxi 78*305 MM Poids 16 kg</p>
	<p>SCIE A RUBAN 120 LD8</p> <p>Puissance 250 W Diamètre des volants 200 MM Capacité de coupe maxi 80 MM Col de cygne 200 MM Longueur de lame 1 425 MM</p>
	<p>SCIE A CHANTOURNER 405VE</p> <p>Puissance 80 W Col de cygne 405 MM Capacité de coupe maxi 57 MM Longueur de lame 127 MM Inclinaison de la table 45 °</p>

Autres Matériels Peugeot

	<p>SUPPORT POUR PERCEUSE FILAIRE SP 500 B</p> <p>Largeur 152 MM Hauteur 500 MM Dimension table principale 152x180 MM Diamètre 43 MM</p>
	<p>SUPPORT POUR MEULEUSE D'ANGLE dia 115</p> <p>Pour diamètre 230 mm Poids 5.45 kg Longueur 375 mm Largeur 375 mm Hauteur de plateau 370 mm</p>
	<p>COMBINE PONCEUR -200ASP</p> <p>Diamètre 200 mm Dimension 100 x 915 mm Puissance 500 W Tension 230 V - Monophasé</p>

Matériel Fartools



SEMEM DISTRIBUTORS SARL

Meuleuses

	MEULEUSE dia 125
	Vitesse de rotation 10500 tours/min Poids net 3.15 kg Puissance absorbée 1200 W Puissance utile 1200 W Diamètre du disque 125 mm

	MEULEUSE dia 230
	Meuleuse d'angle KL 230C Puissance : 2 200 W Diamètre : 230 mm Alésage : 22,2 mm

	TRONCONNEUSE METAL
	Puissance 2480W Diamètre 355MM Alésage 25,4MM Capacités de coupe droite 105MM Vitesse de rotation 3800TR/MIN

Perceuses / Chignoles

	PERCEUSE 1200W
	Puissance 1200W Nombre de vitesses mécaniques 2 Capacité de serrage du mandrin 13MM Vitesse de rotation 0-1200/0-3200TR/MIN Fréquence de frappe 0-19200/0-51200CPS/MIN

	PERCEUSE SANS FIL 18V
	Tension 18V Type de batterie Li-ion Ampérage de la batterie 3.0/1.5AH Couple maximum 60N/M

	PERCEUSE SANS FIL 18V REF 215445
	Tension 18V Type de batterie Li-ion Ampérage de la batterie 3.0/1.5AH Couple maximum 60N/M



PERCEUSE D'ETABLI DPB 25E

Puissance 550W
Capacité de serrage du mandrin 1-16MM
Vitesse de rotation 180-2770TR/MIN
Diamètre colonne 72MM
Hauteur 860MM



PERCEUSE D'ETABLI DPB 35E

Puissance 750W
Capacité de serrage du mandrin 1-16MM
Vitesse de rotation 180-2770TR/MIN
Diamètre colonne 80MM
Hauteur 1000MM



PERCEUSE A COLONNE DPB 45C

Puissance 550W
Capacité de serrage du mandrin 1-16MM
Vitesse de rotation 180-2770TR/MIN
Diamètre colonne 72MM
Hauteur 1560MM



PERCEUSE A COLONNE DPB 35C

Puissance 750W
Capacité de serrage du mandrin 1-16MM
Vitesse de rotation 180-2770TR/MIN
Diamètre colonne 80MM
Hauteur 1580MM



MARTEAU PERFORATEUR REF 115475

Puissance 1600W
Puissance de frappe 6.0 JOULES
Type de montage SDS
Fréquence de frappe 4000CPS/MIN
Vitesse de rotation 800TR/MIN



MARTEAU PERFORATEUR REF 115700

Watt 1500 Watts
Longueur du cordon 2.4 mètres
Poids 10.7 kilogrammes
Type de batterie / pile Lithium



BRISE BETON REF 115369

Puissance 1700W
Puissance de frappe 60 JOULES
Fréquence de frappe 1900CPS/MIN
Niveau de vibration 17,787M/S2

Ponceuses et Raboteuses

	RABOTEUSE REF 115493
	Puissance 850W Longueur du fer 82MM Fonction feuillure 12MM Largeur du fer 6MM Epaisseur du fer 1,25MM Vitesse de rotation 16500TR/MIN

	PONCEUSE RECTANGULAIRE REF 115160
	Puissance 350W Longueur de l'abrasif 228MM Largeur de l'abrasif 114MM Type de montage Auto agrippant Vitesse de rotation 6000-12000TR/MIN

	PONCEUSE EXCENTRIQUE REF 115136
	Puissance 200W Longueur de l'abrasif 140MM Largeur de l'abrasif 80MM Type de montage auto agrippant Vitesse de rotation 15000TR/MIN

	PONCEUSE A BANDE REF 115471
	Puissance 1200W Longueur de l'abrasif 610MM Largeur de l'abrasif 100MM Vitesse d'avance 500M/S Longueur câble d'alimentation 2,00M

	PONCEUSE DELTA REF 115135
	Puissance 180W Longueur de l'abrasif 90MM Largeur de l'abrasif 90MM Vitesse de rotation 10000TR/MIN

	PONCEUSE POLISSEUSE
	Puissance 1500W Diamètre 180MM Type de filetage M14 Vitesse de rotation 0-3200TR/MIN

	COMBINE PONCEUR REF 113203
	Puissance 370W Longueur de l'abrasif 915MM Vitesse d'avance 8.3M/S Vitesse de rotation 2850TR/MIN

	DEFONCEUSE REF 115470
	Puissance 1300W Pinces admissibles 8/12MM Réglage de la course 0->55MM Vitesse de rotation 11000-28000TR/MIN

Scies Electriques

	<p>SCIE SAUTEUSE REF 115330</p> <p>Watt 800 Watts Longueur du cordon 2 mètres Type de batterie / pile Lithium Poids 2.60 kilogrammes</p>
	<p>SCIE ELECTRIQUE</p> <p>Puissance 1400 W Diamètre 185 mm Alésage 20 mm Capacité de coupe maxi 63 mm</p>
	<p>SCIE A ONGLET REF 113211</p> <p>Puissance 1650W Diamètre 210MM Capacité de coupe maxi 210x60MM Alésage 25,4MM Vitesse de rotation 5000TR/MIN</p>
	<p>SCIE A ONGLET REF 113212</p> <p>Puissance 2000W Diamètre 305MM Capacité de coupe maxi 90MM Alésage 25,4MM Vitesse de rotation 4350TR/MIN</p>
	<p>SCIE ORBITAL REF 115156</p> <p>Puissance 450W Diamètre de l'abrasif 125MM Vitesse de rotation 6000-12000TR/MIN Type de montage auto agrippant</p>
	<p>SCIE DE TABLE + ONGLET REF 113393</p> <p>Puissance 1800W Diamètre 255MM Capacité de coupe maxi 63x153 mm Alésage 30MM Vitesse de rotation 4200TR/MIN</p>
	<p>SCIE A CHANTOURNER REF 113258</p> <p>Puissance 150W Col de cygne 410MM Capacité de coupe maxi 40MM Longueur de lame 127MM Vitesse de rotation 1400TR/MIN</p>
	<p>SCIE A RUBAN REF 113292</p> <p>Puissance 750W Capacité de coupe maxi 160MM Col de cygne 305MM Vitesse de rotation 1400TR/MIN Type de table Aluminium</p>

Autres Matériels Fartools

	<p>ASPIRATEUR EAU + POUSSIERE</p> <p>Type de cuve Inox Volume d'air traité 1,992M3/H Puissance 1400W Volume de la cuve 25L</p>
	<p>TOURET A MEULER</p> <p>Puissance 550W Diamètre 200MM Diamètre 2 200 Alésage 16MM</p>
	<p>ETAU D'ETABLI dia 125</p> <p>Mâchoire en acier démontable : 125 mm Fixation sur plan de travail Ouverture : 65 mm Base pivotante : 360°</p>
	<p>ETAU D'ETABLI dia 150</p> <p>Mâchoire en acier démontable : 150 mm Fixation sur plan de travail Ouverture : 135 mm Base pivotante : 360°</p>
	<p>ETAU D'ETABLI dia 200</p> <p>Mâchoire en acier démontable : 200 mm Fixation sur plan de travail Ouverture : 135 mm Base pivotante : 360°</p>
	<p>PALAN ELECTRIQUE REF 182002</p> <p>Charges maxi 250KG Puissance 500W Type de traction Câble Hauteur de passage maxi 12MM</p>
	<p>PALAN A CHAINE 1T REF 182008</p> <p>Charges maxi 1000KG Hauteur de passage maxi 2500MM Mouflage - Arret d'urgence Sécurité fin de courses - Démarrage progressif</p>
	<p>PALAN A CHAINE 2T REF 182009</p> <p>Charges maxi 2000KG Hauteur de passage maxi 2500MM Mouflage - Arret d'urgence Sécurité fin de courses - Démarrage progressif</p>
	<p>GROUPE ELECTROGENE 3200W REF 118030</p> <p>Puissance 3000W Réservoir d'essence 15L Moteur 4 Temps de 9 cv Autonomie maximum 8 heures Indicateur faible niveau d'huile</p>

Abrasifs et Consommables



DISQUES A COUPER

DISQUE A COUPER dia 115 DISQUE A COUPER dia 300
DISQUE A COUPER dia 125 DISQUE A COUPER dia 350
DISQUE A COUPER dia 230 DISQUE A COUPER dia 400



DISQUES A MEULER

DISQUE A MEULER dia 115
DISQUE A MEULER dia 125
DISQUE A MEULER dia 230



DISQUES DIAMANT

DISQUE DIAMANT dia 115
DISQUE DIAMANT dia 125
DISQUE DIAMANT dia 230



DISQUES A PONCER

DISQUE A PONCER dia 125
DISQUE A PONCER dia 180
GRAINS : 24, 36, 60, 80, 100, 120



DISQUES A LAMELLE

DISQUE A LAMELLE dia 125
DISQUE A LAMELLE dia 115



DISQUES AUTOAGRIPANT

DISQUE AUTOAGRIPANT dia 125
DISQUE AUTOAGRIPANT dia 150



PAPIER A BANDE



JEU DE CHARBON DE RECHANGE

EQUIPEMENT DE PROTECTION INDIVIDUELLE



SEMEM DISTRIBUTORS

Protection de la tête, des mains, du corps et des pieds

Équipement de Protection Individuelle

Un équipement de protection individuelle (EPI) est un élément destiné à protéger d'un ou de plusieurs risques à un poste de travail. Ces équipements de protection individuelle sont définis comme « tout dispositif ou moyen destiné à être porté ou tenu par une personne en vue de la protéger contre un ou plusieurs risques susceptibles de menacer sa santé ainsi que sa sécurité au travail, ainsi que tout complément ou accessoire destiné à cet objectif ».

Sommaire

Protection de la tête

Protection des yeux

Protection du corps

Protection des mains

Protection des pieds

Sécurité et Signalisation



SEMEM DISTRIBUTORS SARL

Protection de la Tête



CASQUE DE CHANTIER OPUS



CASQUE DE CHANTIER OPALE



CASQUE + MENTONNIÈRE



CASQUE FORESTIER



CASQUE + LUNETTE



CASQUE + PROTECTION AUDITIVE



VISIÈRE DE PROTECTION PERFORÉE



VISIÈRE DE PROTECTION PVC



CASQUE ANTI BRUIT MAX 200



CASQUE ANTI BRUIT MAX 300



CASQUE ANTI BRUIT MAX 400



BOUCHONS ANTI BRUITS RELIÉS



BOUCHONS ANTI BRUITS INDÉPENDANTS

Masques



MASQUE D'HYGIÈNE BLANC



MASQUE D'HYGIÈNE BLEU



MASQUE PLIABLE SIMPLE



**MASQUE PLIABLE
AVEC SOUPAPE D'EXPIRATION**



MASQUE COQUE SIMPLE



**MASQUE COQUE
AVEC SOUPAPE D'EXPIRATION**



**MASQUE PLIABLE AVEC SOUPAPE
D'EXPIRATION**



**MASQUE EUROMASK UNO
SANS CARTOUCHE**



**MASQUE EUROMASK UNO
AVEC CARTOUCHE**



**MASQUE EUROMASK DUO
SANS CARTOUCHE**



**MASQUE EUROMASK DUO
AVEC CARTOUCHE**



**MASQUE PANORAMIQUE
POLYCARBOMASK SANS CARTOUCHE**



**MASQUE PANORAMIQUE
POLYCARBOMASK AVEC CARTOUCHE**



**CARTOUCHE DE RECHARGE POUR
MASQUE EUROMASK**



**CARTOUCHE DE RECHARGE POUR
MASQUE PANORAMIQUE**

Protection des Yeux



VISILUX SIMPLE



VISILUX TEINTÉ NOIR



MONOLUX



SOUDLUX



DUOLUX (SPÉCIALE SOUDURE)



REVLUX



VERRES DE SOUDURE TEINTÉ



VERRES DE SOUDURE CLAIR



VRILUX SURLUNETTE



VRILUX TEINTÉ JAUNE



VRILUX TEINTÉ NOIR



VRILUX SIMPLE



PIVOLUX TEINTÉ NOIR



PIVOLUX BRAS BLEU



PIVOLUX TEINTÉ NOIR



PIVOLUX BRAS ROUGE

Protection du Corps



COMBINAISONS DE TRAVAIL



COMBINAISONS DE SÉCURITÉ



TENUE DE TRAVAIL 2 PIÈCES



ENSEMBLES DE PLUIE



MANTEAU DE PLUIE



TABLIERS PVC



VESTE DE SOUDEUR



TABLIER DE SOUDEUR



MANCHETTE



GUETRE



COMBINAISON JETABLE

Protection des Mains

1. Gant Manutention



**GANT DOCKERS
(CROÛTE SUPÉRIEURE DE VACHETTE)**



**GANT DOCKERS
(CROÛTE DE VECHETTE)**



**GANT DOCKERS (CROÛTE
SUPÉRIEURE DE VACHETTE GRISE)**



**GANT DOCKERS
(CROÛTE DE VECHETTE)**



**GANT DOCKERS
(CROÛTE DE VECHETTE)**

2. Gant Soudeur



**GANT SOUDEUR
(FLEUR DE VACHETTE)**



**GANT SOUDEUR
(TOUT CROÛTE DE VACHETTE)**



**GANT SOUDEUR
(TOUT FLEUR DE VACHETTE)**



**GANT SOUDEUR
(TOUT CROÛTE DE VACHETTE)**



**GANT SOUDEUR
(CUIR CROÛTE DE VACHETTE SUPÉRIEURE)**

4. Gant Anti-coupure



GANT NITRILE GRIS



GANT TRICOTÉ 100% POLYAMIDE GRIS



GANT TRICOTÉ 100% POLYAMIDE BLANC

3. Gant PVC



GANT PVC ROUGE 36



GANT NÉOPRÈNE / NITRILE



GANT NÉOPRÈNE / NITRILE PLUS



GANT LATEX DE MÉNAGE ROSE



GANT LATEX SUR JERSEY COTON



GANT PVC BLEU 34



GANT VINYLE, AMBIDEXTRE

3. Gant de finition



GANT COTON CROISÉ

Protection des Pieds



STOPAC S3



AGATH S1



DELTA PLUS S1

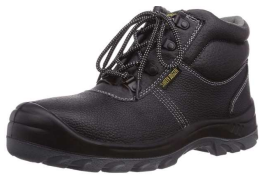

PROMAX



DELTA PLUS S3



BOTTE PVC



BOTTE DE SÉCURITÉ



BOTTE DE SÉCURITÉ



BOTTE DE SÉCURITÉ PVC NOIR



STOPAC

Sécurité et Signalisation



KIT ANTICHUTE



HARNAIS COMPLET AVEC CEINTURE DE MAINTIEN ET CORDE



CEINTURE DE MAINTIEN AU TRAVAIL



MOUSQUETON ACIER À VIS



LONGE DE SÉCURITÉ RÉGLABLE + CONNECTEUR



LONGE DE SÉCURITÉ 1,5M



GILET BAUDRIER JAUNE



GILET BAUDRIER ORANGE



BAUDRIER DE SIGNALISATION



CÔNE DE SIGNALISATION LUMINEUX



CÔNES DE SIGNALISATION

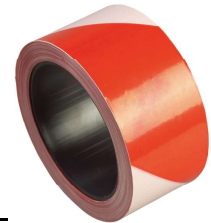

RUBAN DE SIGNALISATION



GRILLAGE DE SIGNALISATION



CHAÎNE DE SIGNALISATION



GYROPHARE DE SIGNALISATION



EXTINCTEUR À EAU



EXTINCTEUR À POUDRE



EXTINCTEUR CO2

Matériel
**CONSTRUCTION
& QUINCAILLERIE**



SEMEM DISTRIBUTORS SARL

Matériel de construction

Les matériaux de construction sont des matériaux utilisés dans les secteurs de la construction : bâtiment et travaux publics (souvent désignés par le sigle BTP). La gamme des matériaux utilisés dans la construction est relativement vaste. Elle inclut principalement le bois, le verre, l'acier, les matières plastiques (isolants notamment) et les matériaux issus de la transformation de produits de carrières, qui peuvent être plus ou moins élaborés. On a ainsi dérivés de l'argile, les briques, les tuiles, les carrelages, les éléments sanitaires.

Sommaire

TÔLES DE COUVERTURE ET ACCESSOIRES

ETANCHEITE ET COLLE

SERRURERIE

OUTILS ET CONSOMMABLES



SEMEM DISTRIBUTORS SARL

LES QUALITÉS DE L'ALUMINIUM

Inaltérable

L'aluminium est très résistant aux agents atmosphériques. Au contact de l'air, il se recouvre spontanément d'une pellicule d'oxyde transparente continue et étanche. Grâce à cette propriété, l'aluminium ne rouille pas.

Résistant

L'aluminium n'est ni cassant, ni fragile. De plus il est imputrescible, hydrofuge et ignifuge. Aucun entretien n'est à prévoir.

Isolant

L'aluminium a un excellent pouvoir réfl échissant aux rayons solaires. Grâce à cette propriété, une toiture en aluminium protège efficacement contre les rayons solaires et conserve la chaleur en périodes froides.

Non toxique

Aucun sel d'aluminium n'étant toxique, on peut sans danger recueillir l'eau de pluie sur les toits en aluminium.

Ininflammable

La température de fusion du métal est élevée (658°). Aucun risque de propagation d'incendie n'est à craindre.

... et il ne rouille pas

POINTES ORDINAIRES



MARQUE	DIMENSIONS	CONDITIONNEMENTS
Pointe du Cameroun	- TP30 - TP80 - TP40 - TP90 - TP50 - TP100 - TP60 - TP110 - TP70 - TP120	- Paquet de 5Kg - Carton de 50 Kg - Conditionnement personnalisé à la demande

POINTES ORDINAIRES



MARQUE	DIMENSIONS	CONDITIONNEMENTS
Pointe du Cameroun	- PT60 lisse - PT60 torsadé - PT70 lisse - PT70 torsadé - PT80 lisse - PT80 torsadé	- Paquet de 3Kg - Carton de 25 Kg

Tôles de couverture et accessoires

1. Tôles aluminium nues



2. Tôles aluminium laquées

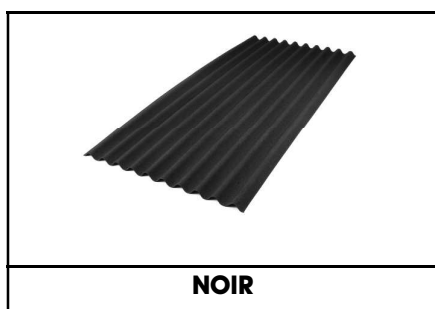

**100% ALU
SOCATRAL**

3. Tôles translucides



4. Accessoires de toiture

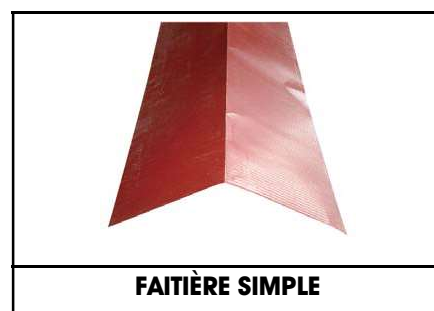



FAITIÈRE MOULÉE 10 COTÉS



BOUCHON FAITIÈRE MOULÉE

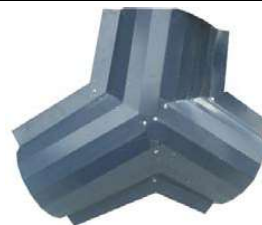

RACCORD Y FAITIÈRE MOULÉE



NOUE EN U



NOUE EN V

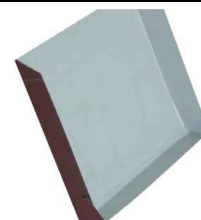

BOUCHON NOUES



GOUTTIÈRE EN A

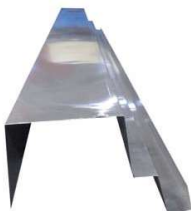

GOUTTIÈRE EN B



GOUTTIÈRE EN C



GOUTTIÈRE OURLÉE

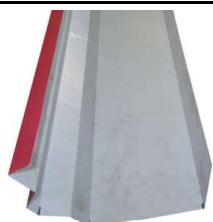

GOUTTIÈRE DÉCORÉE



GOUTTIÈRE AVEC NAISSANCE

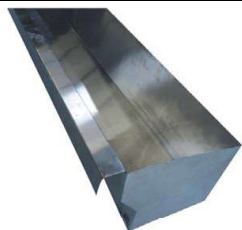

GOUTTIÈRE AVEC BOUCHON



GOUTTIÈRE AVEC NAISSANCE ET BOUCHON



ANGLE GOUTTIÈRE NORMAL 90°, 120°



ANGLE GOUTTIÈRE INVERSÉ 90°, 120°



ANGLE GOUTTIÈRE AVEC NAISSANCE FIXÉE



ANGLE GOUTTIÈRE AVEC BOUCHON



NAISSANCE



BOUCHON GOUTTIÈRE A

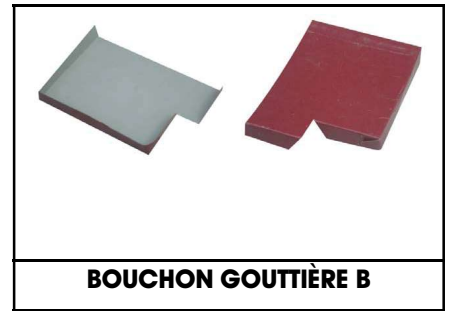

BOUCHON GOUTTIÈRE B



BOUCHON GOUTTIÈRE C

5. Fixations



TENDEUR OU CROCHET SIMPLE

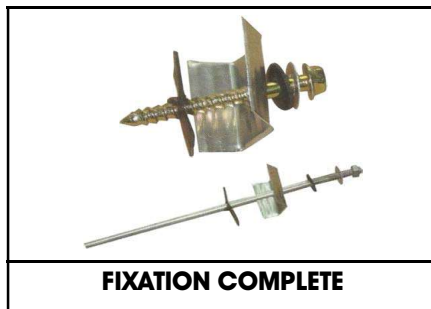

FIXATION COMPLETE



CAVALIER ET RONDELLE



RONDELLE FEUTRE



PLAQUETTE FEUTRE



POINTES A TOILE



POINTES ORDINAIRE



RIVET



RIVETEUSE

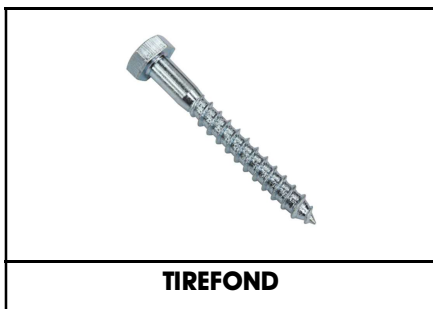

TIREFOND



TIGE ALU

Serrurerie

1. Serrure et Cadenas Vachette Assa-Abloy



SERRURE MEUBLE



CYLINDRE PRO6R



CYLINDRE PRO5R NICRELE



CYLINDRE 7000 LAITON 30x30L



CYLINDRE VRX



CYLINDRES VACHETTE



GARNITURE SABINE F1045



GARNITURE SAUMUR G9045



POIGNEE ARTIS CHROME VELOURS



POIGNEE ARTIS PLATINE CLE



POIGNEE ARTIS DIAMANT NOIR CLE



POIGNEE ARTIS CHROME VELOUR BCC



POIGNEE MUZE PLATINE CLE



POIGNEE MUZE DIAMANT NOIR CLE



GARNITURE DOUCHE BCC S3084



SERRURE DOUCHE BCC G9013



SERRURE ANGERS G3083



GARNITURE ENDURANCE G3373



POIGNEE KOSMO ROSACE CLE



POIGNEE LOGIO BCC



CADENAS ULISEE 1313



POIGNEE KOSMO ROSACE BCC



GARNITURE BCC 9013



SERRURE D450

2. Serrure Yale



GARNITURE YALE GENOVA ARGENT



GARNITURE YALE VERONA ARGENT



**GARNITURE YALE BOLOGNA
NICKEL SATINE**



**GARNITURE YALE BOLOGNA
VENEZIA SATINE**

3. Autres



VERROU PRIMA BOUTON



FERME PORTE



SERRURE A 3 POINTS



VERROU V136



BUTES DE PORTE

Etanchéité et Colle

1. Etanchéité du toit



2. Etanchéité de la maison





SIKA DECOFFRE MINERAL



SIKAFLEX PRO



SIKALATEX TONNEL 20L

3. Etanchéité des circuits de plomberie



COLLE TANGIT



COLLE GEBGOPLAST



COLLE GEBAJOINT

4. Colle à bois



COLLE AGOPLAC



COLLE PATTEX



COLLE EMFI

Outils et consommables

1. Outils de chantier



SEAU MAÇON



TALOCHE



MARTEAU



VIBREUR À BÉTON



NIVEAU D'EAU



TRUELLE



ECHELLE



ÉCHAFAUDAGE



ESCABEAU



MONTE CHARGE



PALAN ÉLECTRIQUE



PALAN MANUEL



MOTOPOMPE



GRILLAGE AVERTISSEUR



BANDE DE SIGNALISATION



AUGE MAÇON



LAMPE DE CHANTIER



RADIO DE CHANTIER



MARTEAU DEMOLISSEUR



ROUE DE MESURE



DISQUE DIAMANT



HARNAIS COMPLET AVEC CEINTURE DE MAINTIEN ET CORDE



KIT ANTICHUTE



CEINTURE DE MAINTIEN AU TRAVAIL



MOUSQUETON ACIER À VIS



MASSETTE



MESURE



BURIN



RALLONGE



BROUETTE



GILET BAUDRIER JAUNE



CASQUE DE CHANTIER



GANT MANUTENTION



CASQUES ANTI BRUIT

2. Matériaux et Divers



PLATRE



CIMENT COLLE



CIMENT BLANC



CIMENT ORDINAIRE



FER A BETON



SANITAIRES



GRILLAGE AVERTISSEUR



GRILLAGE CLOTURE



FIL D'ATTACHE



GRATTOIR A PEINTURE



FIL A PLOMB



PELLE RONDE



PELLE BECHE



RATEAU



PIOCHE



BARRE A MINE

3. Outils de chantier



DAME SAUTEUSE



BETONNIERE



VIBREUR A BETON



TELEMETRE LASER



POINTE ORDINAIRE



POINTE A TOLE



POINTE TOC

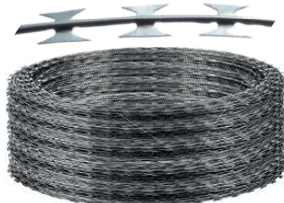

BARBELE RASOIR

Equipements
& Outillages

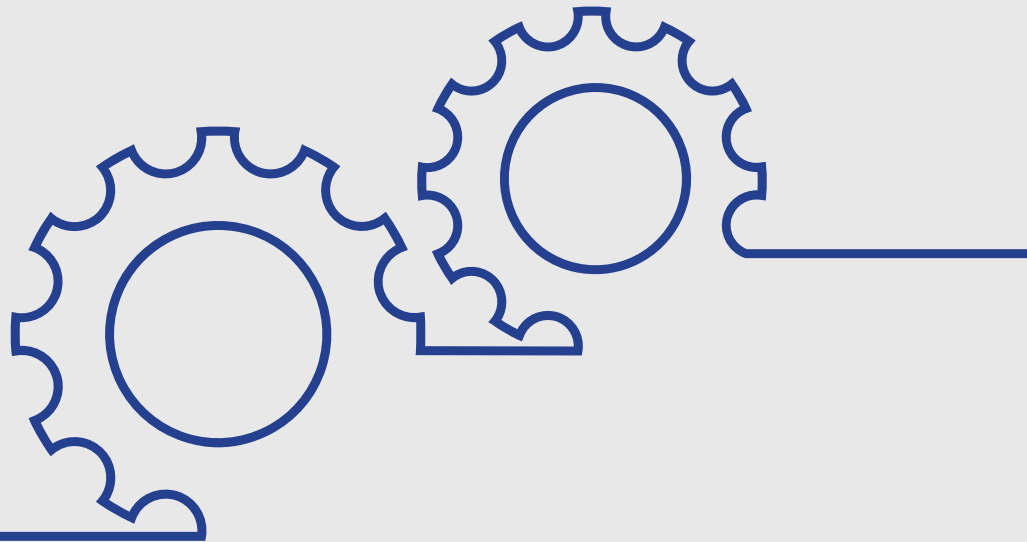

**Industriels
& Artisansaux**



SEMEM DISTRIBUTORS SARL

Equipement

Action d'équiper, de pourvoir quelqu'un de ce qui est nécessaire. Action d'aménager un endroit, de pourvoir quelque chose du matériel nécessaire.

Outillage

Ensemble des outils ou appareils nécessaires à une profession, à une fabrication, ou qui équipent une machine ou un poste de travail.

Industriel

Se dit d'un lieu où sont implantées des usines, des industries.

Artisanal

Qui est élaboré selon des méthodes traditionnelles, individuelles. Qui relève de l'artisan, qui concerne l'artisanat.

Sommaire

EQUIPEMENT

OUTILLAGE



SEMEM DISTRIBUTORS SARL



PALAN ELECTRIQUE



PALAN MANUEL



ETAU D'ETABI



MOTOPOMPE



POMPE IMMERGEE



50L, 100L, 500L, 1000L

COMPRESSEUR



KATCHER



MEULEUSE



PERCEUSE



PONCEUSE



SCIE CIRCULAIRE



SCIE A ONGLET



GRUE D'ATELIER



CRIC HYDRAULIQUE



PRESSE HYDRAULIQUE



PERCEUSE A COLONNE



PERCEUSE MAGNETIQUE



COUPE CARREAUX MANUEL



COUPE CARREAUX ELECTRIQUE



THERMOMETRE LASER



LEVE BLOCK



MONTE CHARGE



CHARIOT PORTE BOUTEILLE



TRANSPALETTE



MANOMETRE DE GONFLAGE



SUPRESSEUR



CAISSE A OUTILS



COFFRET DE FORET A BETON



COFFRET DE FORET ACIER



SERVANTE D'ATELIER



COFFRET A CLE



COFFRET DE DOUILLE



ECHELLE A PLUSIEURS PLAN



ECHELLE COULISSANT



ECHELLE SIMPLE



ESCABEAU



ECHAFFAUDAGE



ENTONNOIR



COFFRET FRAISE A DEFONCER



MARTEAU ARACHE CLOU



FILTRE A EAU



FILTRE DESHYDRATEUR / REGULATEUR



RABOT



BURETTE A HUILE



PISTOLET DECAPEUR REGLABLE



DETECTEUR DE CABLE



RIVETUSE



MESURE



CLE A CHAINE POUR FILTRE



POMPE ROTATIVE GASOIL



KIT SCIE TREPAU



LAMPE BALADEUSE



DEBROUSSAILLEUSE



POMPE A GRAISSE



TENAILLE RUSSE



TIREFORT



CABLE DE DEMARRAGE BATTERIE



TESTEUR DE BATTERIE



CHARGEUR DEMARREUR



CHAUFFAGE ELECTRIQUE



COUPEAU A ENDUIRE



TOURET A MEULER



SUPPORT POUR PERCEUSE



PISTOLET DE PEINTURE



LAMPE A SOUDER



CHANDELLE DE CREMAILLERE



JEU DE PINCE A CIRCLIP



TOURNEVIS A FRAPPER



CLE A MOLETTE



CLE A FRAPPER



CLE A GRIFFE



CISAILLE A TOLE



SANGLE



MASSETTE



MONTURE DE LAME DE SCIE



DECAMETRE



NIVEAU D'EAU



EXTRACTEUR DE ROULEMENT



JEU DE DEMONTE PNEU



JEU DE TOURNEVIS DE PRECISION



JEU DE CHASSE GOUPILLE



JEU DE CLE ALLEN



CISAILLE A FLEUR



COUPE BOULON



PINCE A SERTIR



GRAVEUR ELECTRIQUE



AUGE MACON



SEAU MACON



COUTEAU ELECTRICIEN



Matériel

FORESTIER & SCIERIE



SEMEM DISTRIBUTORS SARL

Forestier

Le matériel forestier est l'ensemble des outils mécaniques spécifiquement destinés au travail en forêt (sylviculture, bûcheronnage, débardage, etc.).

Scierie

Une scierie est une installation industrielle ou artisanale de sciage du bois ou du marbre. Les scieries sont des industries de première transformation du bois.

Sommaire

FEUILLARD DE CERCLAGE

CABLES

LAMES DE SCIE

MEULES D'AFFUTAGE

STELLITE GRADE 12

OUTILLAGE ET CONSOMMABLE DE SCIERIE

PROTECTION DU FORESTIER



SEMEM DISTRIBUTORS SARL

Feuillard de cerclage

1. Feuillard Textile

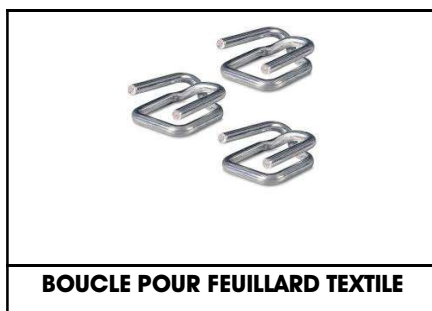

2. Feuillard Polyester (Plastique)



3. Feuillard Galva



Cables



CABLES DE DEBARDAGE (en 100m)

CABLE DE DEBARDAGE DE 26
 CABLE DE DEBARDAGE DE 28
 CABLE DE DEBARDAGE DE 30
 CABLE DE DEBARDAGE DE 32



CABLES ANTIGIRATOIRES (en 300m)

CABLE ANTIGIRATOIRE DE 16 EN 100M
 CABLE ANTIGIRATOIRE DE 18 EN 100M
 CABLE ANTIGIRATOIRE DE 20 EN 100M
 CABLE ANTIGIRATOIRE DE 26
 CABLE ANTIGIRATOIRE DE 28
 CABLE ANTIGIRATOIRE DE 30



CABLE ACIER (en 100m)

CABLE ACIER DE 6
 CABLE ACIER DE 8
 CABLE ACIER DE 10
 CABLE ACIER DE 12
 CABLE ACIER DE 14
 CABLE ACIER DE 16
 CABLE ACIER DE 18
 CABLE ACIER DE 20
 CABLE ACIER DE 22

Lame de scie



LAME DE SCIE A RUBAN UDDELHOM



LAME DE SCIE A RUBAN 130 x 1,2 CTB60 (m)
 LAME DE SCIE A RUBAN 155 x 1,47 CTB60 (m)
 LAME DE SCIE A RUBAN 180 x 1,47 CTB60 (m)
 LAME DE SCIE A RUBAN 206 x 1,47 CTB60 (m)
 LAME DE SCIE A RUBAN 206 x 1,65 CTB60 (m)
 LAME DE SCIE A RUBAN 260 x 1,47 CTB60 (m)
 LAME DE SCIE A RUBAN 260 x 1,65 CTB60 (m)
 LAME DE SCIE A RUBAN 260 x 1,65 CTB50 (m)
 LAME DE SCIE A RUBAN 285 x 1,65 CTB60 (m)
 LAME DE SCIE A RUBAN 311 x 1,65 CTB60 (m)





LAME DE CIRCULAIRE

LAME DE SCIE CIRCULAIRE 300 x 2,2 x 30 Z36
 LAME DE SCIE CIRCULAIRE 350 x 2,2 x 30 Z36
 LAME DE SCIE CIRCULAIRE 400 x 3,6 x 30 Z48
 LAME DE SCIE CIRCULAIRE 450 x 4 x 30 Z56
 LAME DE SCIE CIRCULAIRE 500 x 4 x 30 Z64
 LAME DE SCIE CIRCULAIRE 600 x 4 x 30 Z54

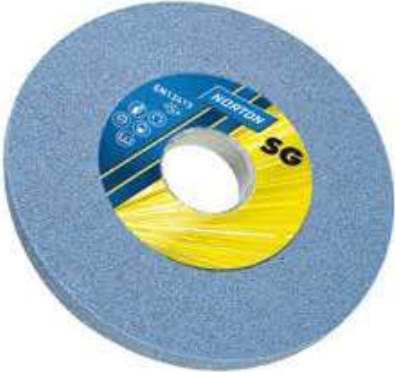
Meules d'affutage

	<p>MEULE DIAMANT</p> <p>MEULE DIAMANT 125 x 5 X 4 X 20 MEULE DIAMANT 150 x 5 X 4 X 20</p>
	<p>MEULE DIABOLO</p> <p>MEULE DIABOLO 90 x 40 x 22</p>
	<p>MEULE BOISSEAU</p> <p>MEULE BOISSEAU 80 x 40 x 20 MEULE BOISSEAU 125 x 40 x 20 MEULE BOISSEAU 150 x 40 x 20</p>
	<p>MEULE PLATE</p> <p>MEULE PLATE 200 x 10 x 32 T3 MEULE PLATE 200 x 10 x 32 D3 MEULE PLATE 200 x 13 x 32 T3 MEULE PLATE 200 x 13 x 32 D3 MEULE PLATE 230 x 13 x 32 T3 MEULE PLATE 230 x 13 x 32 D3 MEULE PLATE 250 x 13 x 32 T3 MEULE PLATE 250 x 13 x 32 D3 MEULE PLATE 250 x 16 x 32 T3 MEULE PLATE 250 x 16 x 32 D3 MEULE PLATE 300 x 20 x 32 T3 MEULE PLATE 300 x 20 x 32 D3</p>

Stellite Grade 12

	<p>STELLITE GRADE 12</p> <p>STELLITE GRADE 12 dia 3,2 x 1000 STELLITE GRADE 12 dia 4 x 1000 STELLITE GRADE 12 dia 5 x 1000 STELLITE GRADE 12 dia 6,4 x 1000</p>
	<p>DISQUE POUR COUPER LA STELLITE</p> <p>DISQUE COUPE STELLITE dia 115 x 1 DISQUE COUPE STELLITE dia 125 x 1</p>

Outillage et Consommable de Scierie



**CERCLEUSE POUR FEUILLARD
DE 16, 19 et 32**



TOURET A MEULER



TRONÇONNEUSE A CHAINE STIHL



TIREFORT 3,2T



MEULEUSE ELECTRIQUE GWS 26-30



PERCEUSE ELECTRIQUE GWS 21RE



COMPRESSEUR A AIR 270L



PALAN A CHAINE 2T



PALAN A LEVIER 3T



CHANDELLE 6T, 3T



BATTERIE 100A, 120A, 180A, 240A



MOTEUR ASYNCHROME

Consommables



CHAINES POUR TRONÇONNEUSE 11BC



LIME RONDE



CRAIE A MARQUER



CRAIE ORDINAIRE



JEU DE LETTRE A MARQUER 50MM



JEU DE CHIFFRE A MARQUER 50MM



JEU DE LETTRE A FRAPPER 8MM



JEU DE CHIFFRE A FRAPPER 8MM



MARTEAU NUMEROTEUR



GRAISSE



FUT DE CEREMUL

Protection du Forestier

1. Protection de la tête



2. Protection de la main



2. Protection de la main



TENUE DE TRAVAIL



CHAUSSURES DE SECURITE STOPAC



CHAUSSURES DE SECURITE DETAPLUS



MANTEAU DE PLUIE



BOTTE PVC



BOTTES DE SECURITE



www.sememdistributors.com



SEMEM DISTRIBUTORS SARL

Douala Direction Générale

(Akwa - Carrefour Tif)

Tél.: (237) 233 42 25 24

Email: contact@sememdistributors.com

Camp Yabassi

(Agence Junior)

Tél.: (237) 233 43 64 78

Email: contact@sememdistributors.com

Yaoundé Olézoa

(à coté de Prestige Hôtel)

Tél.: (237) 222 22 30 68

Email: yaounde@sememdistributors.com

Yaoundé Centrale

(Derrière BICEC Centrale)

Tél.: (237) 222 22 30 68

Email: yaounde@sememdistributors.com

Garoua

(Rue MTN)

Tél.: (237) 222 27 25 27

Email: garoua@sememdistributors.com

Bafoussam

(Carrefour Feu Rouge)

Tél.: (237) 233 44 31 49

Email: bafoussam@sememdistributors.com